

San Ace 36 ^{9HV type}

High Static Pressure Fan

Features

High Static Pressure and High Airflow

This fan delivers a maximum static pressure of 1,400 Pa and a maximum airflow of 0.72 m³/min. Compared with the current model,* the maximum static pressure has increased by 1.67 times and maximum airflow has increased by 1.04 times.

Space-saving

This fan provides the same cooling performance as our conventional 40 × 40 mm fans.** The reduced fan size enables enhanced design flexibility.

High Energy Efficiency and Low Noise

The PWM control function enables the external control of fan speed, contributing to lowering noise and improving energy efficiency of devices.

* Current model: *San Ace 36 9GX* type 36 × 36 × 28 mm (9GX3612P3K001).
 ** Conventional fans: 40 × 40 × 28 mm *San Ace 40 9GV* type (9HV0412P3K001) and 9GAX type (9GAX0412P3S001).



36 × 36 × 28 mm

Specifications

The models listed below **have ribs and pulse sensors with PWM control function.**

Model no.	Rated voltage [V]	Operating voltage range [V]	PWM duty cycle* [%]	Rated current [A]	Rated input [W]	Rated speed [min ⁻¹]	Max. airflow [m ³ /min] [CFM]	Max. static pressure [Pa] [inchH ₂ O]	SPL [dB(A)]	Operating temperature [°C]	Expected life [h]
9HV3612P3K001	12	10.8 to 13.2	100	1.75	21.0	32500	0.72 25.4	1400 5.62	67	-20 to +60	30000/60°C
			20	0.05	0.6	6000	0.12 4.2	47.2 0.19	26		

* PWM frequency: 25 kHz. Fan does not rotate when PWM duty cycle is 0%.
 Models with the following sensor specifications are also available as options: **Without sensor** **Lock sensor**

Common Specifications

- Material Frame: Plastic (Flammability: UL 94V-0), Impeller: Plastic (Flammability: UL 94V-1)
- Expected life Refer to specifications
(L10 life: 90% survival rate for continuous operation in free air at 60°C, rated voltage)
- Motor protection system Current blocking function and reverse polarity protection
- Dielectric strength 50/60 Hz, 500 VAC, for 1 minute (between lead wire conductors and frame)
- Sound pressure level (SPL) At 1 m away from the air inlet
- Operating temperature Refer to specifications (Non-condensing)
- Storage temperature -30 to +70°C (Non-condensing)
- Lead wire ⊕ Red ⊖ Black **Sensor** Yellow **Control** Brown
- Mass Approx. 53 g

Airflow - Static Pressure Characteristics

• PWM duty cycle

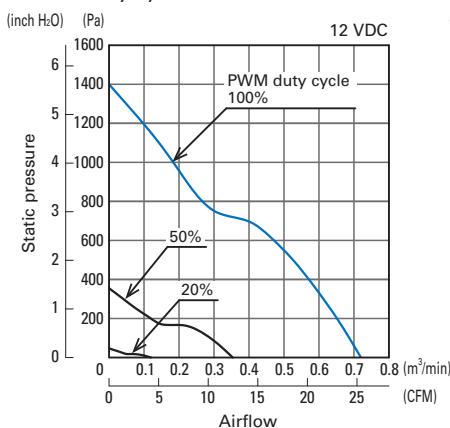

• Operating voltage range

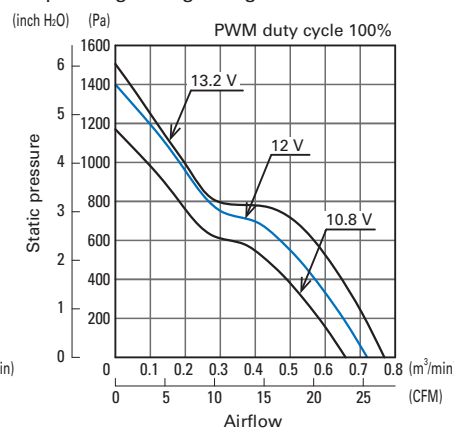

PWM Duty - Speed Characteristics Example

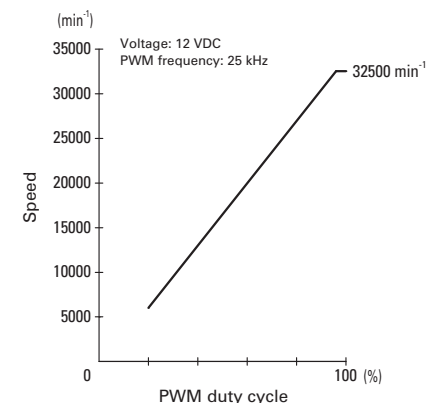

PWM Input Signal Example

Input signal waveform

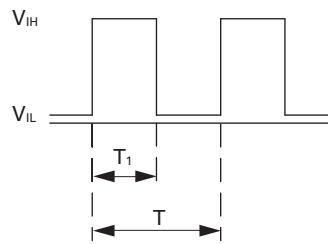

$V_{IH} = 4.75 \text{ to } 5.25 \text{ V}$ $V_{IL} = 0 \text{ to } 0.4 \text{ V}$
 PWM duty cycle (%) = $\frac{T_1}{T} \times 100$ PWM frequency 25 (kHz) = $\frac{1}{T}$
 Current source (I_{source}) = 1 mA max. (when control voltage is 0 V)
 Current sink (I_{sink}) = 1 mA max. (when control voltage is 5.25 V)
 Control terminal voltage = 5.25 V max. (when control terminal is open)

When the control terminal is open,
 fan speed is the same as when PWM duty cycle is 100%.
 Either TTL input, open collector or open drain can be used for PWM control input signal.

Example of Connection Schematic

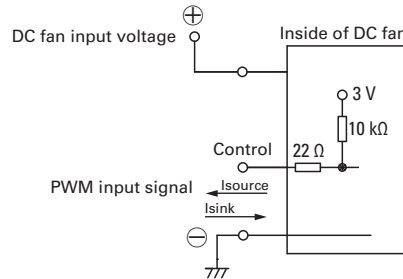

Specifications for Pulse Sensors

Output circuit: Open collector

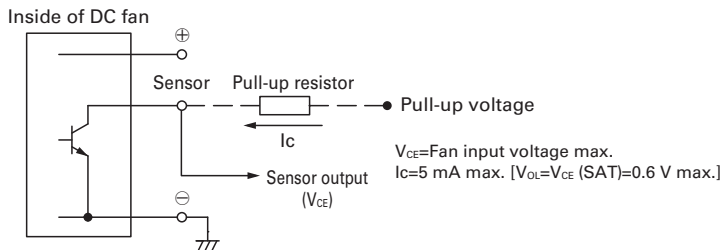

Output waveform (Need pull-up resistor)

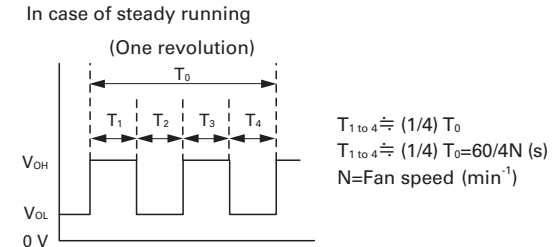

Dimensions (unit: mm)

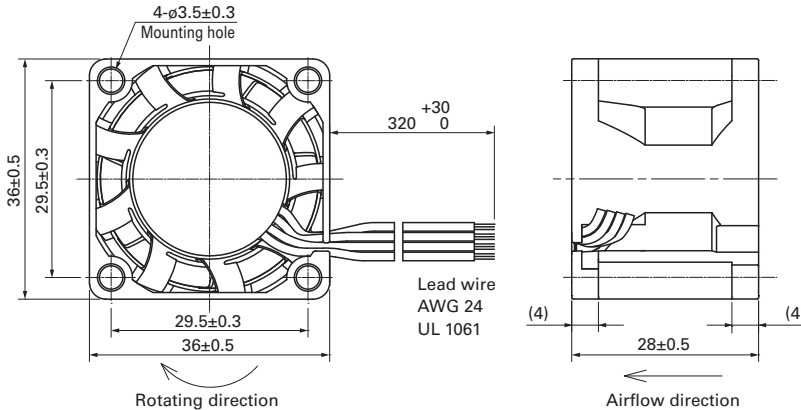

Reference Dimensions of Mounting Holes and Vent Opening (unit: mm)

Inlet side, Outlet side

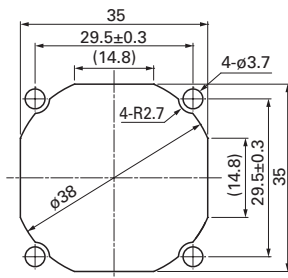

Notice

- Please read the "Safety Precautions" on our website before using the product.
- The products shown in this catalog are subject to Japanese Export Control Law. Diversion contrary to the law of exporting country is prohibited.
- For protecting fan bearings against electrolytic corrosion near strong electromagnetic noise sources, we provide effective countermeasures such as Electrolytic Corrosion Proof Fans and EMC guards. Contact us for details.

SANYO DENKI CO., LTD. 3-33-1, Minami-Otsuka, Toshima-ku, Tokyo 170-8451, Japan TEL: +81 3 5927 1202

<https://www.sanyodenki.com>

The names of companies and/or their products specified in this catalog are the trade names, and/or trademarks and/or registered trademarks of such respective companies.

"San Ace" is a trademark of SANYO DENKI CO.,LTD.

Specifications are subject to change without notice.

CATALOG No. C1089B001 '18.12